

Device handbook

SINEAX DM5S / DM5F

Operating Instructions SINEAX DM5
172 255-08 10/2015

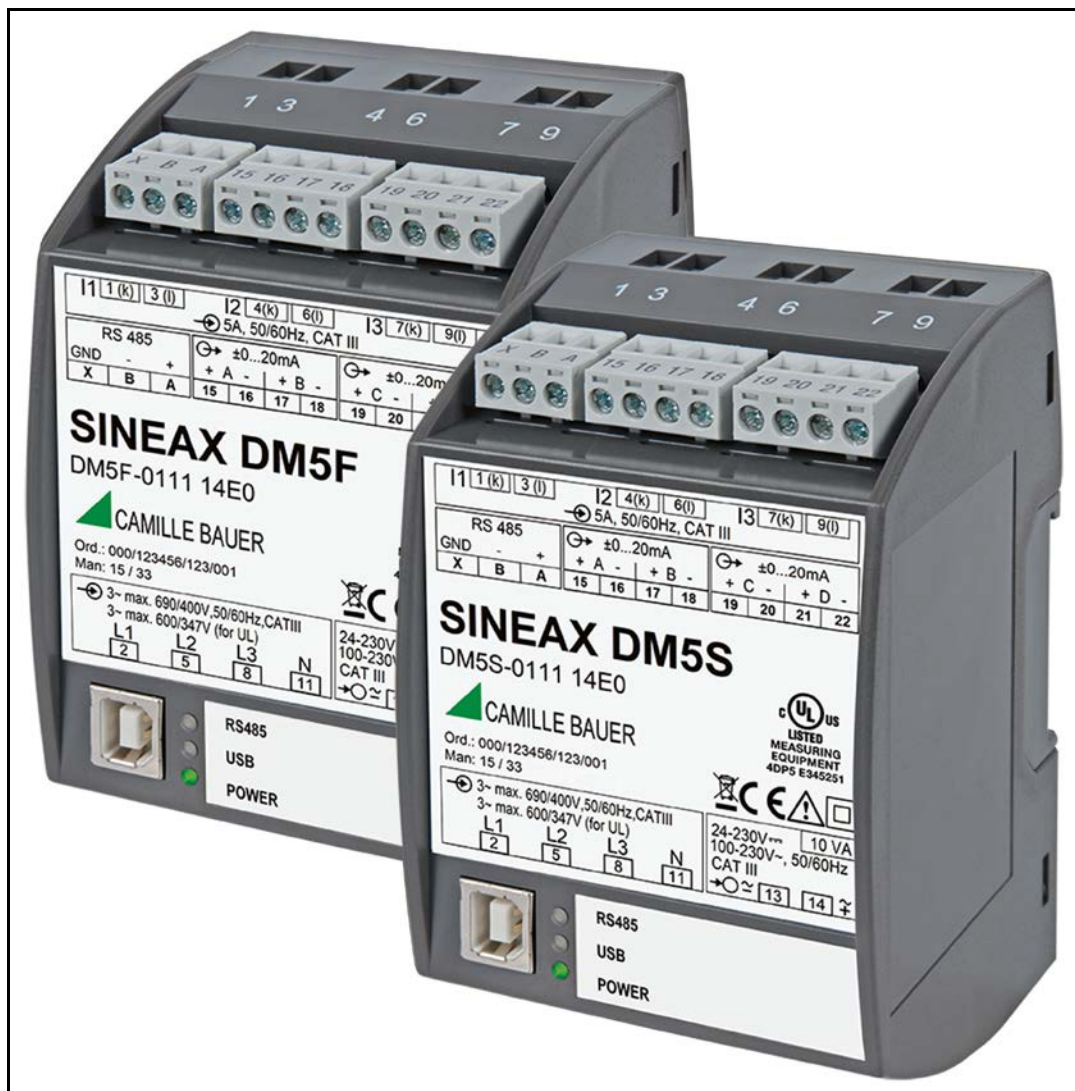

Camille Bauer Metrawatt AG
Aargauerstrasse 7
CH-5610 Wohlen / Switzerland
Phone: +41 56 618 21 11
Telefax: +41 56 618 35 35
e-Mail: info@cbmag.com
<http://www.camillebauer.com>

 CAMILLE BAUER

Legal information

Warning notices

In this document warning notices are used, which you have to observe to ensure personal safety and to prevent damage to property. Depending on the degree of danger the following symbols are used:



If the warning notice is not followed death or severe personal injury **will** result.



If the warning notice is not followed damage to property or severe personal injury **may** result.



If the warning notice is not followed the device **may** be damaged or **may** not fulfill the expected functionality.

Qualified personnel

The product described in this document may be handled by personnel only, which is qualified for the respective task. Qualified personnel have the training and experience to identify risks and potential hazards when working with the product. Qualified personnel are also able to understand and follow the given safety and warning notices.

Intended use

The product described in this document may be used only for the application specified. The maximum electrical supply data and ambient conditions specified in the technical data section must be adhered. For the perfect and safe operation of the device proper transport and storage as well as professional assembly, installation, handling and maintenance are required.

Disclaimer of liability

The content of this document has been reviewed to ensure correctness. Nevertheless it may contain errors or inconsistencies and we cannot guarantee completeness and correctness. This is especially true for different language versions of this document. This document is regularly reviewed and updated. Necessary corrections will be included in subsequent version and are available via our webpage <http://www.camillebauer.com>.

Feedback

If you detect errors in this document or if there is necessary information missing, please inform us via e-mail to: customer-support@camillebauer.com

Contents

1. Introduction	4
1.1 Purpose of this document.....	4
1.2 Scope of supply.....	4
1.3 Further documents	4
2. Security notes.....	5
3. Device overview.....	5
3.1 Brief description.....	5
3.2 Possible modes of operation	6
3.3 Free Modbus image	7
4. Mechanical mounting.....	8
5. Electrical connections	9
5.1 General safety notes	9
5.2 Current connections	10
5.3 Possible cross sections and tightening torques	10
5.4 Inputs	11
5.5 Power supply.....	23
5.6 Analog outputs	23
5.7 Modbus interface RS485	23
5.8 USB configuration interface	24
6. Commissioning.....	25
6.1 Software installation CB-Manager	25
6.2 Parametrization of the device functionality.....	26
6.3 Installation check.....	27
6.4 Protection against device data changing	27
6.5 LED functionality	28
7. Service, maintenance and disposal	29
7.1 Protection of data integrity	29
7.2 Calibration and new adjustment	29
7.3 Cleaning.....	29
7.4 Disposal	29
8. Technical data	30
Annex.....	35
A Description of measured quantities.....	35
A1 Basic measurements	35
A2 Meters (DM5S only)	36
B Declaration of conformity	37
B1 CE conformity.....	37
B2 FCC statement	38
INDEX.....	39

1. Introduction

1.1 Purpose of this document

This document describes the universal measurement device for heavy-current quantities DM5x. It is intended to be used by:

- Installation personnel and commissioning engineers
- Service and maintenance personnel
- Planners

Scope

This handbook is valid for all hardware versions of the DM5. Some of the functions described in this document are available only, if the necessary optional components are included in the device.

Required knowledge

A general knowledge in the field of electrical engineering is required. For assembly and installation of the device knowledge of applicable national safety regulations and installation standard is required.

1.2 Scope of supply



- Measurement device SINEAX DM5S or SINEAX DM5F
- Safety instructions (multiple languages)

1.3 Further documents

On the Doku-CD (not in scope of supply) there are further documents about the DM5. These documents may be downloaded from our homepage <http://www.camillebauer.com/> as well.

- Safety instructions DM5
- Data sheet DM5
- Modbus basics: General description of the communication protocol
- Modbus interface DM5: Register description of Modbus/RTU communication via RS-485

2. Security notes



Device may only be disposed in a professional manner !

The installation and commissioning should only be carried out by trained personnel.

Check the following points before commissioning:

- that the maximum values for all the connections are not exceeded, see "Technical data" section,
- that the connection wires are not damaged, and that they are not live during wiring,
- that the power flow direction and the phase rotation are correct.

The instrument must be taken out of service if safe operation is no longer possible (e.g. visible damage). In this case, all the connections must be switched off. The instrument must be returned to the factory or to an authorized service dealer.

It is forbidden to open the housing and to make modifications to the instrument. The instrument is not equipped with an integrated circuit breaker. During installation check that a labeled switch is installed and that it can easily be reached by the operators.

Unauthorized repair or alteration of the unit invalidates the warranty.

3. Device overview

3.1 Brief description

SINEAX DM5S and SINEAX DM5F are freely programmable universal measurement devices for heavy-current systems: Classical high-accuracy transducers, suited for monitoring tasks and retrofit applications in energy distribution and industry.

The devices can be adapted fast and easily to the measurement task by means of the CB-Manager software – even if there is no power supply available. Depending on the device version measured quantities can be mapped proportional to analog DC current outputs and / or to Modbus.

The measurement is done uninterrupted in all four quadrants and can be adapted optimally to the system to be monitored. Both the average time of the measurement and the expected maximum signal level can be configured.

Device version	SINEAX DM5S	SINEAX DM5F
Number of analog outputs	0,1,2,3 or 4	0,1,2,3 or 4
Modbus/RTU interface	optional	optional
Measurement time, programmable	4...1024 cycles	½,½ (1), 1,2,4,8 cycles
Number of meters	max. 32	none
Auto-scaling V/I inputs	supported	Not supported

Using the device version SINEAX DM5F the behavior of a SINEAX DM5S can be emulated. In this case the DM5F works like a DM5S.

3.2 Possible modes of operation

The DM5x can cover a wide range of possible input ranges without any hardware variance. However, depending on the hardware version ordered some systems may not be available. The adaption to the input signal is performed by means of variable amplifying levels for current and voltage inputs. Depending on the application it makes sense to fix these levels by means of the configuration or to let them stay variable to achieve a maximum accuracy during measurement. The differentiation, if the amplifying remains constant or is adapted to the present value, is done during the definition of the input configuration by means of the parameter "auto-scaling".

The disadvantage of auto-scaling is that when an amplifying level needs to be changed, a settling time of at least one cycle of the power frequency must be allowed until the signals have stabilized again. During this short time the measurement results remain frozen.

Continuous measurement

An absolute uninterrupted measurement of all quantities assumes that auto-scaling is deactivated for both voltage and current inputs.

Metering

The uncertainty of the active energy meters of the DM5S is given with class 0.5S. To fulfill the high requirements of the underlying meter standard EN 62053-22 also small currents have to be measured very accurate. To do so, auto-scaling must be activated for current inputs. For metering applications the system voltage is assumed to be quite constant, nominal value acc. standard, wherefore auto-scaling for voltages is not required.

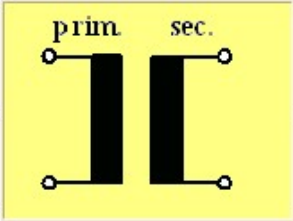
System		4-wire system, asymmetrical			
		<input checked="" type="checkbox"/> right-hand rotation			
voltage input		400.00	V	400.00	[V]
L - L	max.	480.00		480.00	
current input		5.00	A	5.00	[A]
	max.	6.00		6.00	
					
		Overriding		Auto-scaling	
voltage		20.00	%	<input type="checkbox"/>	
current		20.00	%	<input checked="" type="checkbox"/>	



For the device version **DM5F** auto-scaling of voltage and current inputs is not available. As well meters are not supported.

3.3 Free Modbus image

Accessing measured data of a Modbus device often needs some special effort, if the interesting measurements are stored in different, non continuous register areas. This way multiple telegrams must be sent to the device to read all data. This needs time and it's very likely, that the measurements don't originate from the same measurement cycle.

A free assembly of the data to read helps a lot. The DM5x supports, along with the still available classical Modbus image, the facility to assemble an image, which may be read with one telegram only. This freely assembled image is refreshed after each measurement cycle and therefore always provides the most present values.

The free float image

Up to 60 instantaneous values may be arranged in any sequence on the register addresses 40700-40819. All of these values are floating point numbers, which allocate 2 registers per value. Meter values are not possible because they have another format.

The Modbus communication of the DM5 is described in a separate document. This document can be found on the software CD or can be downloaded via our homepage <http://www.camillebauer.com>.

► **W172 445: Modbus/RTU interface DM5** (communication interface RS485)

4. Mechanical mounting

The standard version of the DM5 can be clipped onto a top-hat rail according to EN50022.

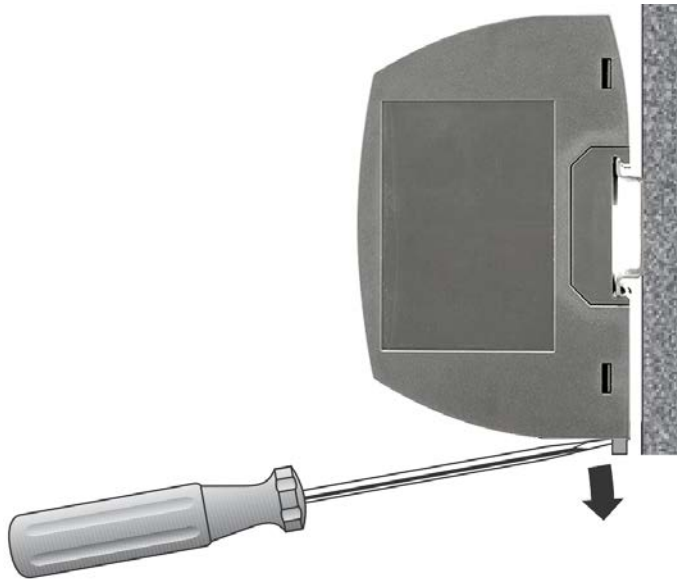

Please ensure that the operating temperature limits are not exceeded when determining the place of mounting (place of measurement):

-20 ... 55°C

5. Electrical connections



Ensure under all circumstances that the leads are free of potential when connecting them !

5.1 General safety notes



Please observe that the data on the type plate must be adhered to !

The national provisions (e.g. in Germany VDE 0100 "Conditions concerning the erection of heavy current facilities with rated voltages below 1000 V") have to be observed in the installation and material selection of electric lines!

11		1 (k)		3 (l)		12		4(k)		6(l)		13		7(k)		9(l)	
→ 5A, 50/60Hz, CAT III																	
RS 485						↻ ±0...20mA						↻ ±0...20mA					
GND -		+				+ A -		+ B -		+ C -		+ D -					
X	B	A				15	16	17	18	19	20	21	22				
SINEAX DM5S																	
DM5S-0111 14E0																	
CAMILLE BAUER																	
Ord.: 000/123456/123/001 Man: 15 / 33																	
↻ 3~ max. 690/400V, 50/60Hz, CAT III						24-230V $\overline{\text{=}}$						10 VA					
3~ max. 600/347V (for UL)						100-230V \sim , 50/60Hz						CAT III					
L1		L2		L3		N				→ \approx		13		14		↻	
2		5		8		11											

Nameplate of a SINEAX DM5S equipped with RS485 interface and 4 analog outputs



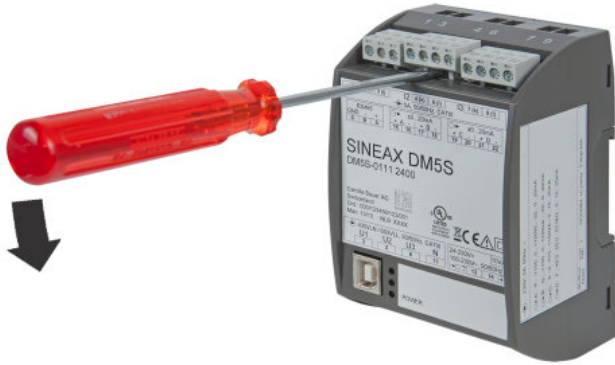

Symbol	Meaning
	Device may only be disposed of in a professional manner!
	Double insulation, device of protection class 2
	CE conformity mark. The device fulfills the requirements of the applicable EC directives. See declaration of conformity .
	Products with this mark comply with both the Canadian (CSA) and the American (UL) requirements.
	Caution! General hazard point. Read the operating instructions.
	General symbol: Input
	General symbol: Output
	General symbol: Power supply
CAT III	Measurement category CAT III for current and voltage inputs

5.2 Current connections

You have to remove first the plug-in terminals to get access to the screw terminals of the current inputs.



5.3 Possible cross sections and tightening torques

I1 1(k) 3(l)			I2 4(k) 6(l)				I3 7(k) 9(l)		
5A, 50/60Hz, CAT III									
RS 485			±0...20mA				±0...20mA		
GND	-	+	+ A -	+ B -	+ C -	+ D -			
X	B	A	15	16	17	18	19	20	21 22
SINEAX DM5S									
DM5S-0111 14E0									
 CAMILLE BAUER									
Ord.: 000/123456/123/001 Man: 15 / 33									
   									
3~ max. 690/400V, 50/60Hz, CAT III				24-230V $\overline{=}$ 10 VA					
3~ max. 600/347V (for UL)				100-230V~, 50/60Hz					
				CAT III					
L1	L2	L3	N	→ ≈ 13 14 ↗					
2	5	8	11						

Inputs L1, L2, L3, N, I1 k-l, I2 k-l, I3 k-l
Power supply 13-14

Single wire

1 x 0,5 ... 6,0mm² or 2 x 0,5 ... 2,5mm²

Multiwire with end splices

1 x 0,5 ... 4,0mm² or 2 x 0,5 ... 2,5mm²

Tightening torque

0,5...0,6Nm resp. 4,42...5,31 lbf in

Analog outputs 15,16,17,18,19,20,21,22

RS485 X, B, A

Single wire

1 x 0,5 ... 2,5mm² or 2 x 0,5 ... 1,0mm²

Multiwire with end splices

1 x 0,5 ... 2,5mm² or 2 x 0,5 ... 1,5mm²

Tightening torque

max. 0,5 Nm resp. 4,42 lbf in

5.4 Inputs



All voltage measurement inputs must originate at circuit breakers or fuses rated 5 Amps or less. This does not apply to the neutral connector. You have to provide a method for manually removing power from the device, such as a clearly labeled circuit breaker or a fused disconnect switch.

When using **voltage transformers** you have to ensure that their secondary connections never will be short-circuited.



No fuse may be connected upstream of the **current measurement inputs** !

When using **current transformers** their secondary connectors must be short-circuited during installation and before removing the device. Never open the secondary circuit under load.

The connection of the inputs depends on the configured system (connection type). Depending on the hardware version ordered some systems may not be available.

System	DM5x-x 1 xx xxxx	DM5x- x 2 xx xxxx	DM5x- x 3 xx xxxx
Single phase system	•	•	•
Split phase (2 phase system)	•	-	-
3-wire, balanced load, phase-shift ^{*)}	•	•	-
3-wire, balanced load	•	•	-
3-wire, unbalanced load	•	-	-
3-wire, unbalanced load, Aron	•	-	-
4-wire, balanced load	•	•	•
4-wire, unbalanced load	•	-	-
4-wire, unbalanced load, Open-Y	•	-	-

^{*)} not supported for SINEAX DM5F

Single-phase AC mains

- Direct connection

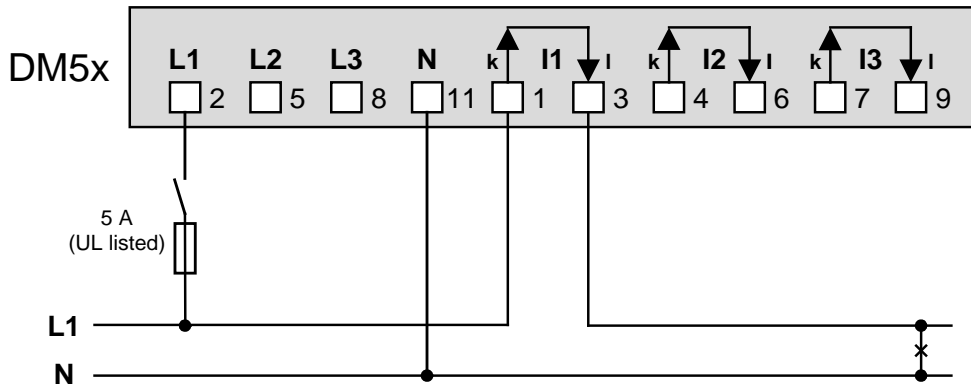

- With current transformer

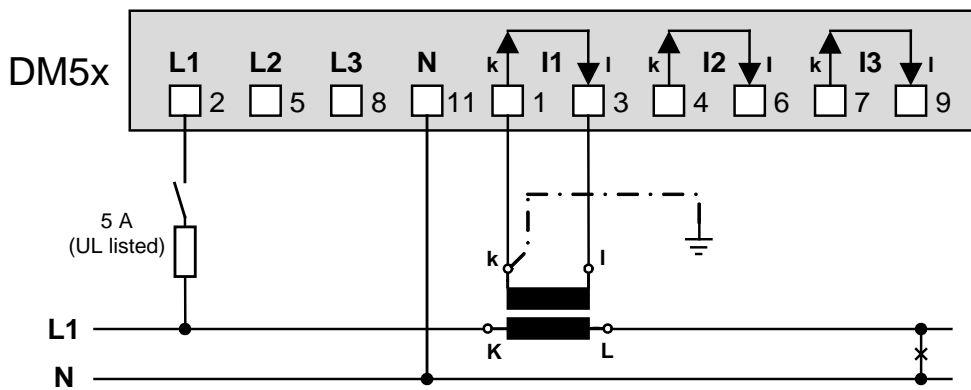

- With current and voltage transformer

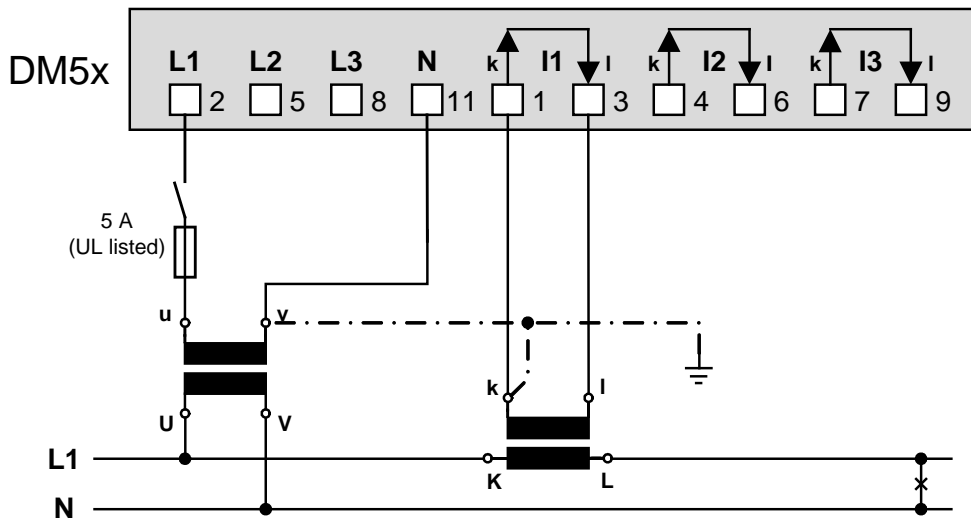

Split-phase ("two phase system"), unbalanced load

- Direct connection

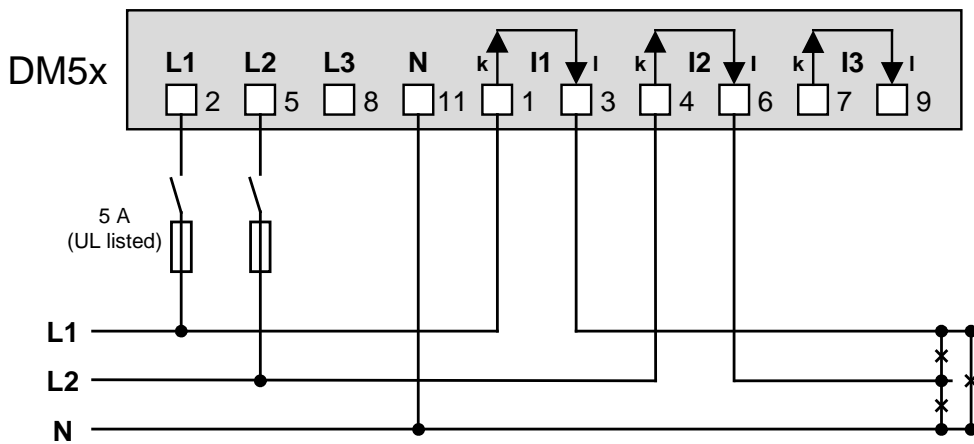

- With current transformer

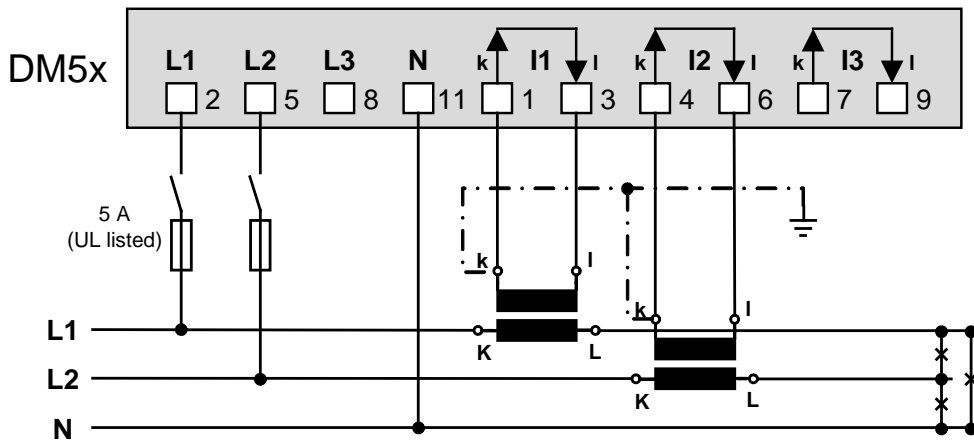

**Three wire system, balanced load, phase-shift
current measurement L1, voltage measurement L1-L2**

- Direct connection

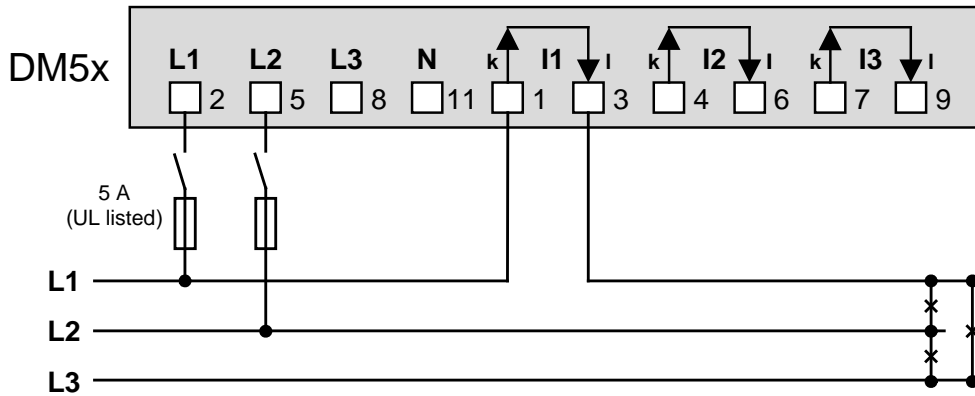

- With current transformer

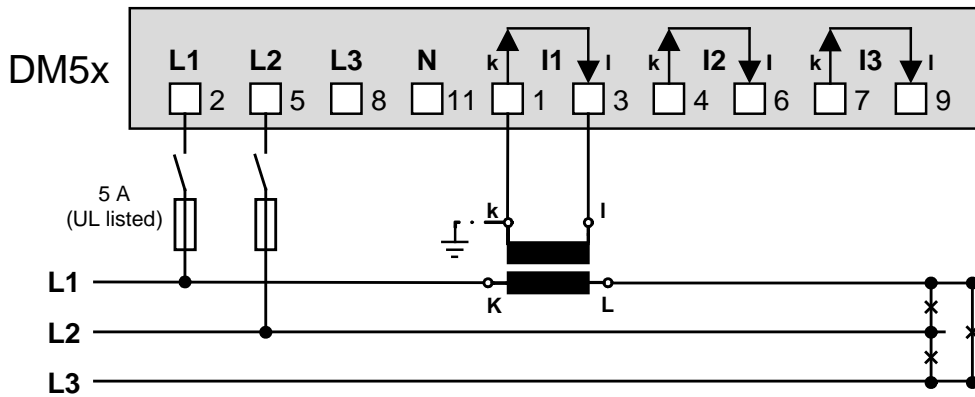

- With current and voltage transformer

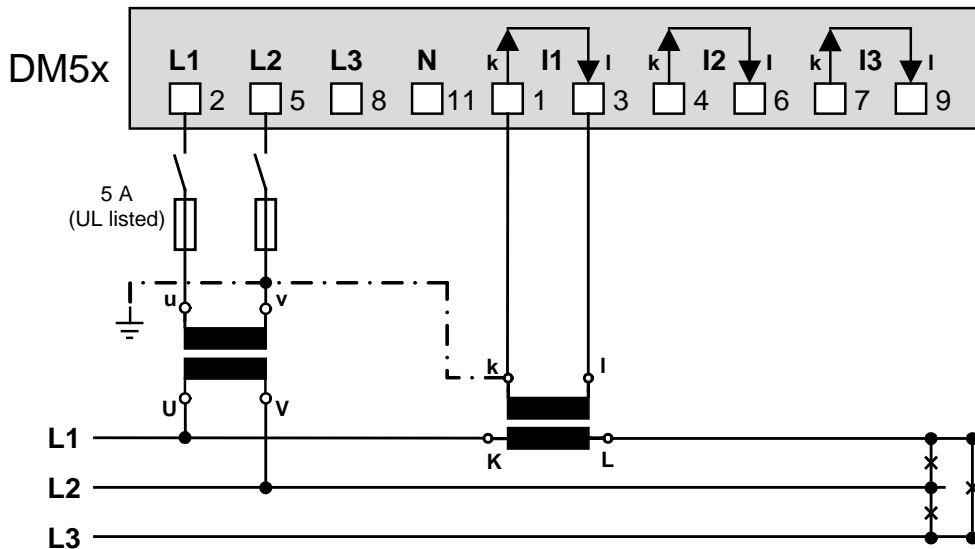

In case of current measurement via L2 or L3 connect voltages-L according to the following table:

Current	Terminals		L1 L2	
	I1-k	I1-I	L2	L3
L2	I1-k	I1-I	L2	L3
L3	I1-k	I1-I	L3	L1

**Three wire system, balanced load, phase-shift
current measurement L1, voltage measurement L2-L3**

- Direct connection

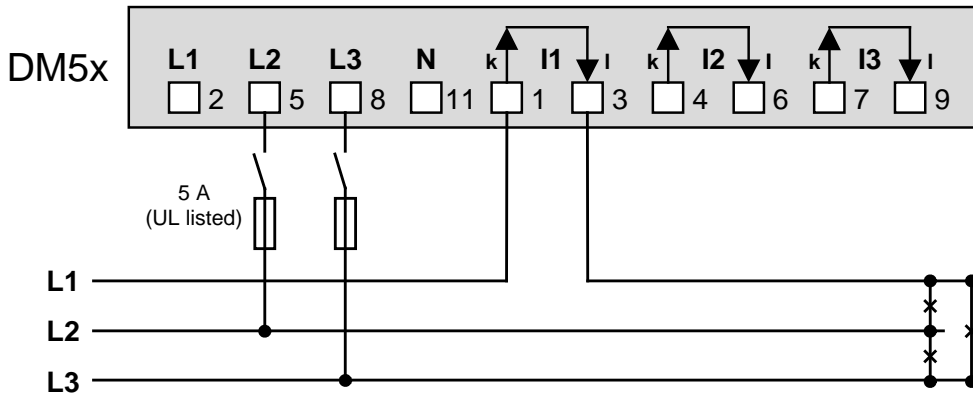

- With current transformer

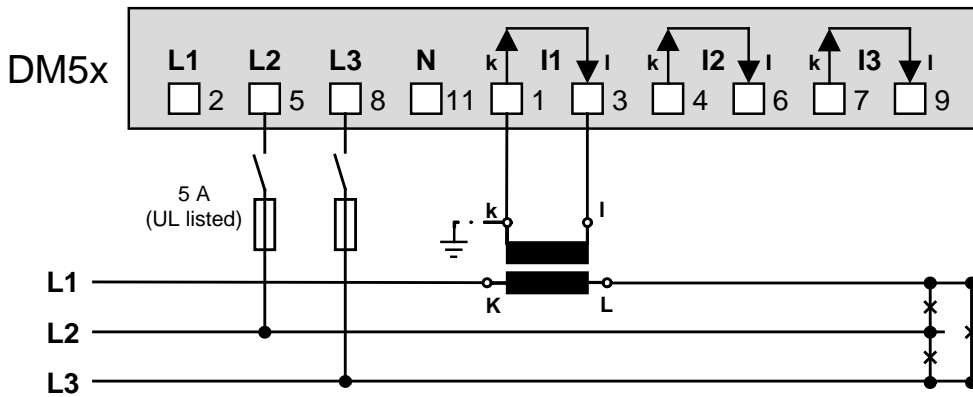

- With current and voltage transformer

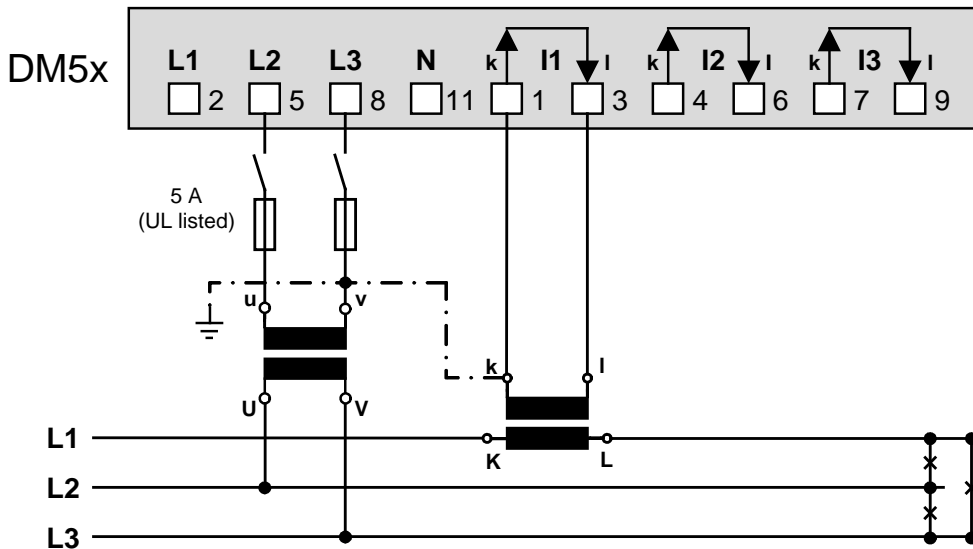

In case of current measurement via L2 or L3 connect voltages according to the following table:

Current	Terminals		L2	L3
	I1-k	I1-I		
L2	I1-k	I1-I	L3	L1
L3	I1-k	I1-I	L1	L2

**Three wire system, balanced load, phase-shift
current measurement L1, voltage measurement L3-L1**

- Direct connection

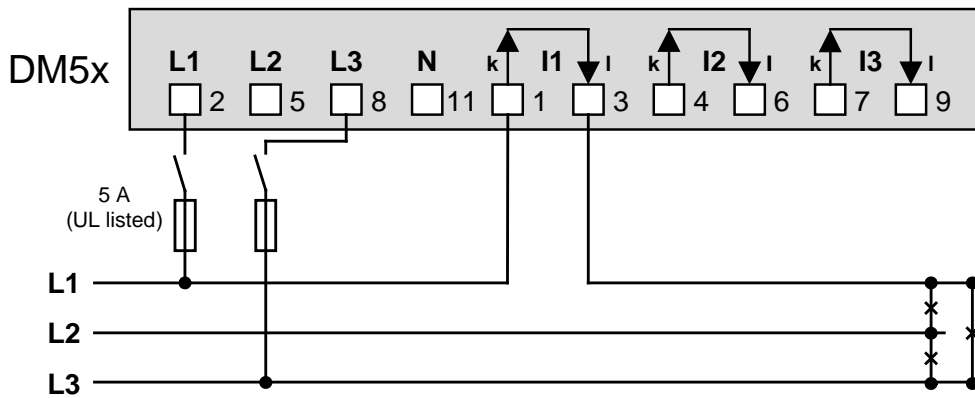

- With current transformer

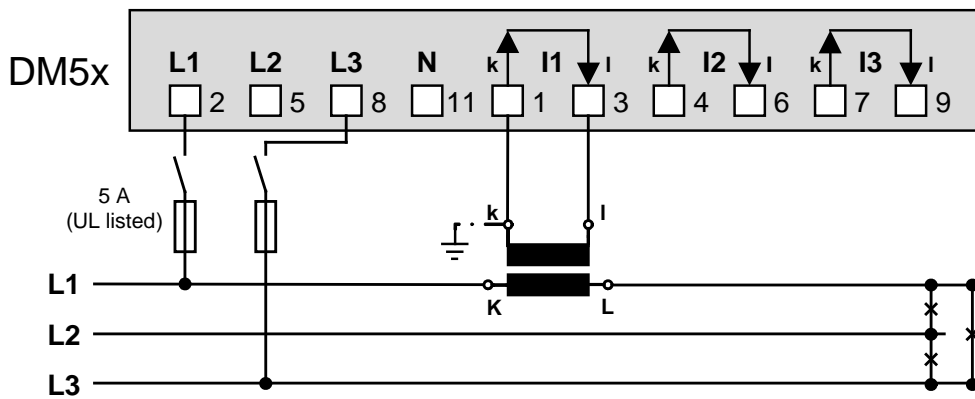

- With current and voltage transformer

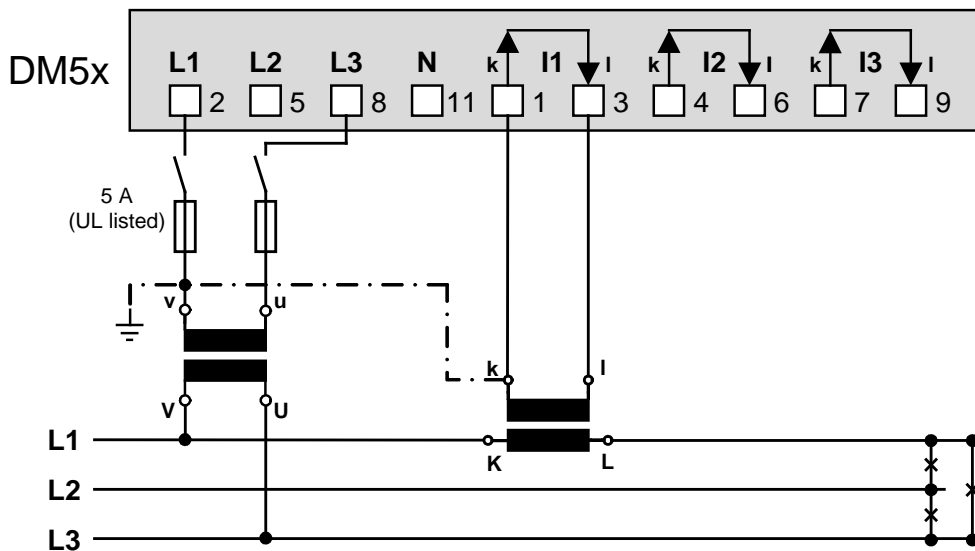

In case of current measurement via L2 or L3 connect voltages according to the following table:

Current	Terminals		L1	L3
	I1-k	I1-I		
L2	I1-k	I1-I	L2	L1
L3	I1-k	I1-I	L3	L2

Three wire system, balanced load, current measurement via L1

- Direct connection

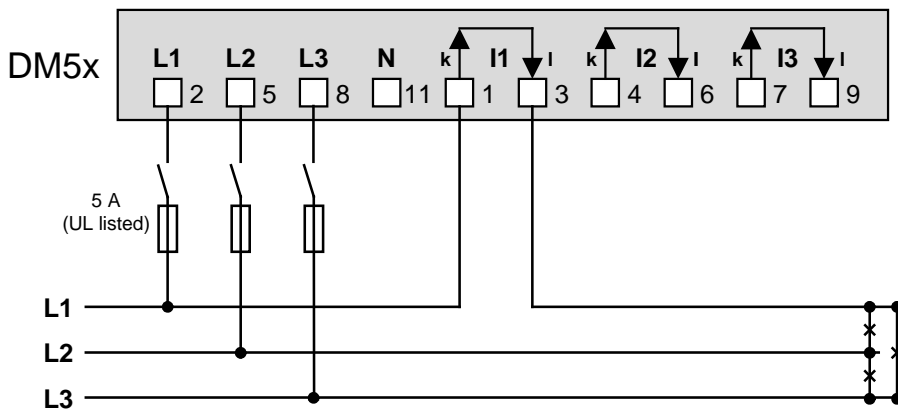

- With current transformer

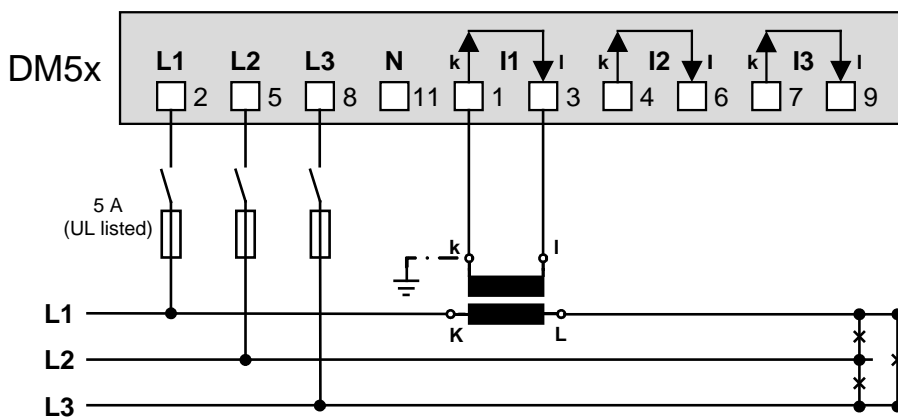

- With current and voltage transformer

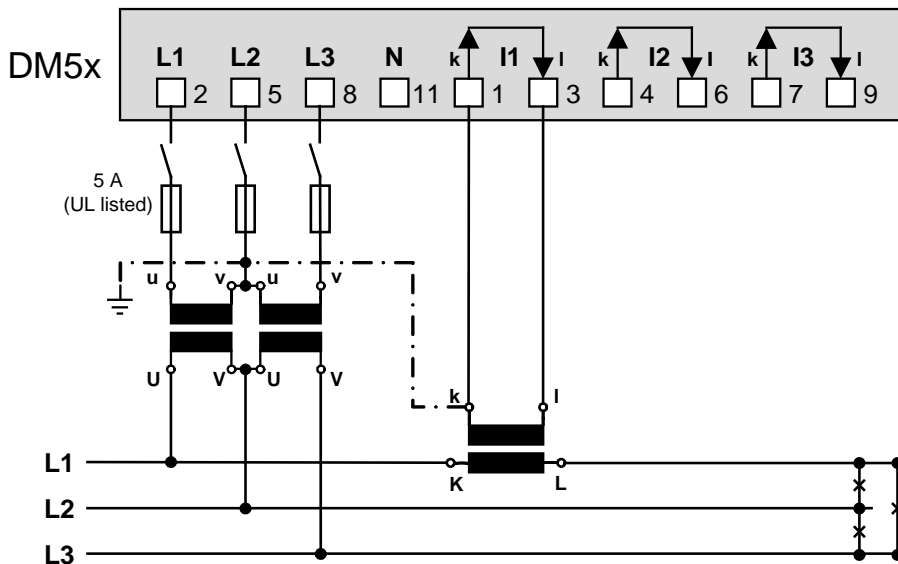

In case of current measurement via L2 or L3 connect voltages according to the following table:

Current	Terminals	L1	L2	L3
L2	I1-k I1-I	L2	L3	L1
L3	I1-k I1-I	L3	L1	L2



By rotating the voltage connections the measurements U_{12} , U_{23} and U_{31} will be assigned interchanged !

Four wire system, balanced load, current measurement via L1

- Direct connection

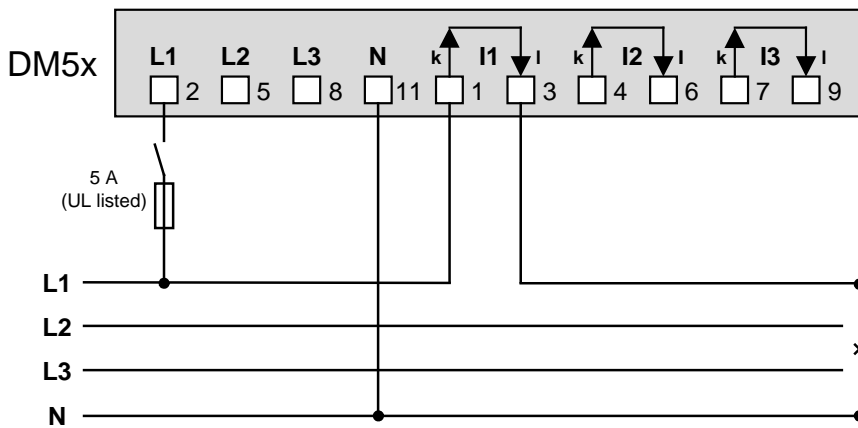

- With current transformer

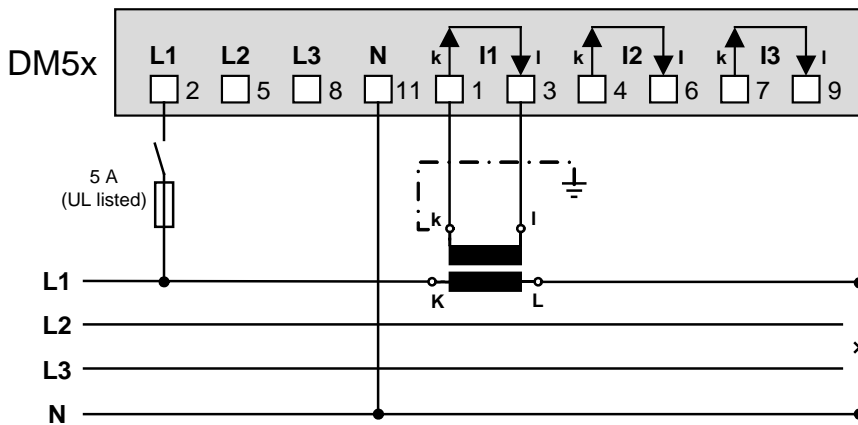

- With current and voltage transformer

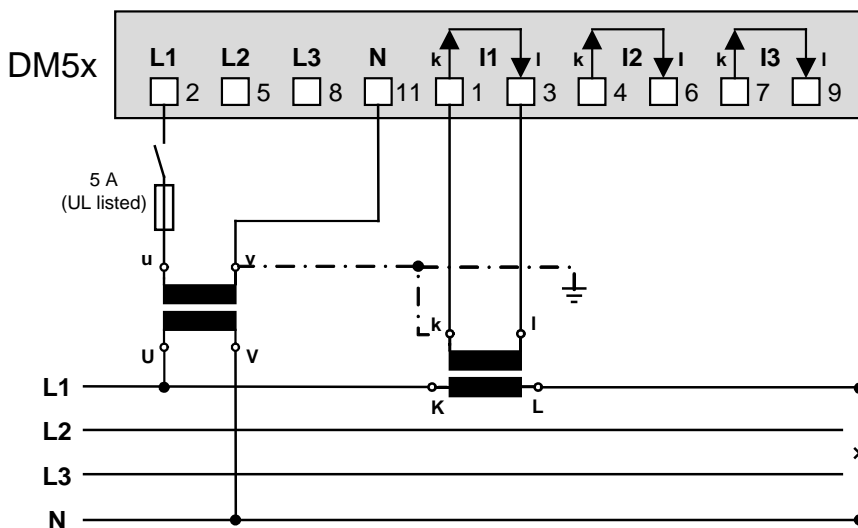

In case of current measurement via L2 or L3 connect voltages according to the following table:

Current	Terminals		L1	N
L2	I1-k	I1-I	L2	N
L3	I1-k	I1-I	L3	N

Three wire system, unbalanced load

- Direct connection

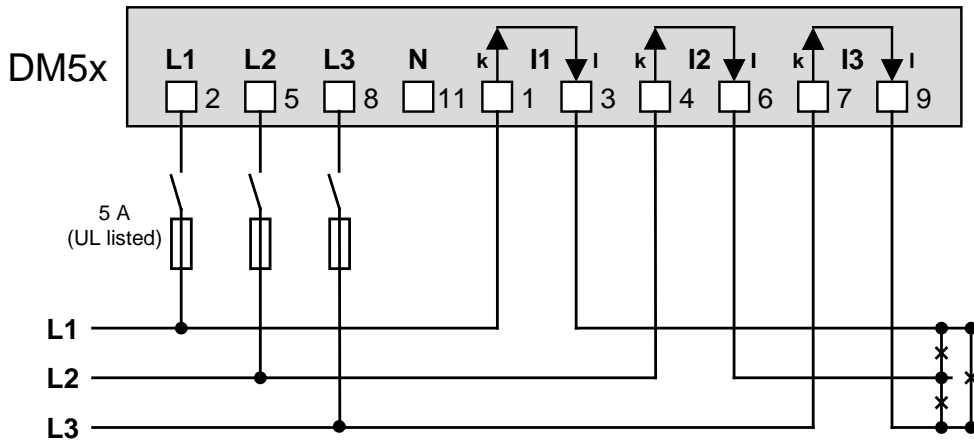

- With current transformer

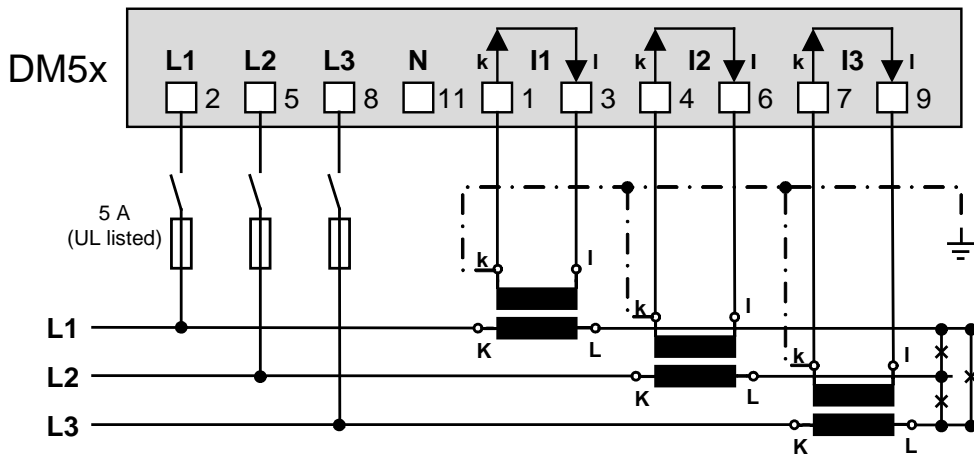

- With current and 3 single-pole isolated voltage transformers

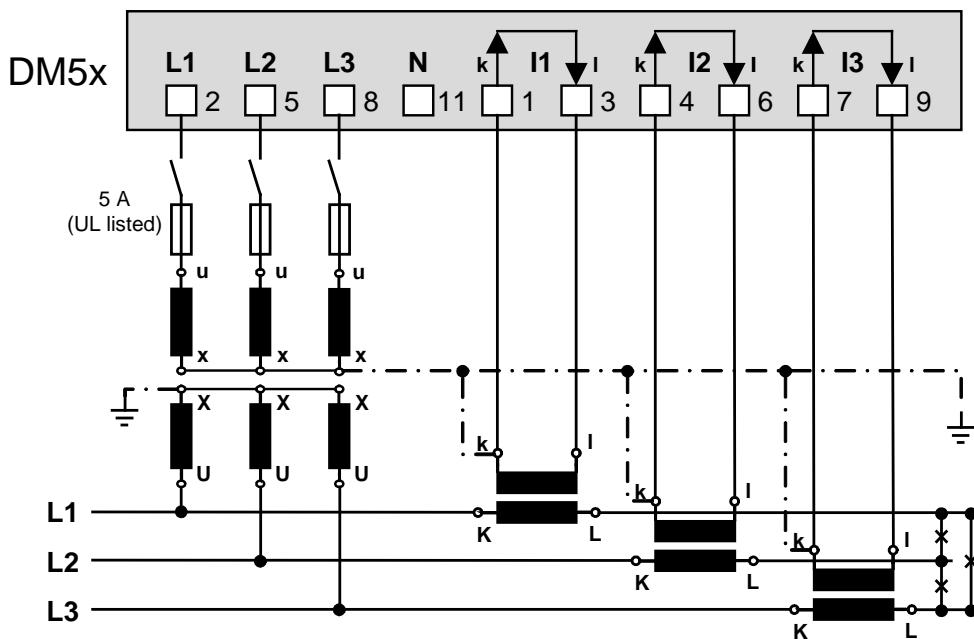

Three wire system, unbalanced load, Aron connection

- Direct connection

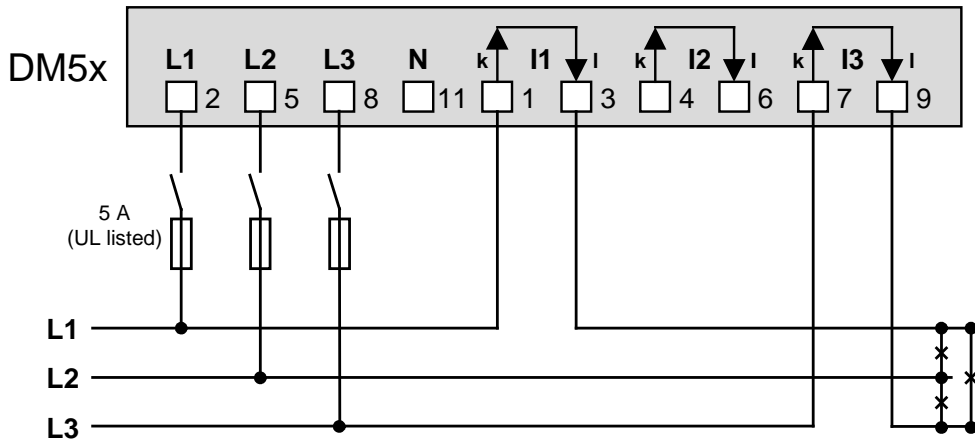

- With current transformer

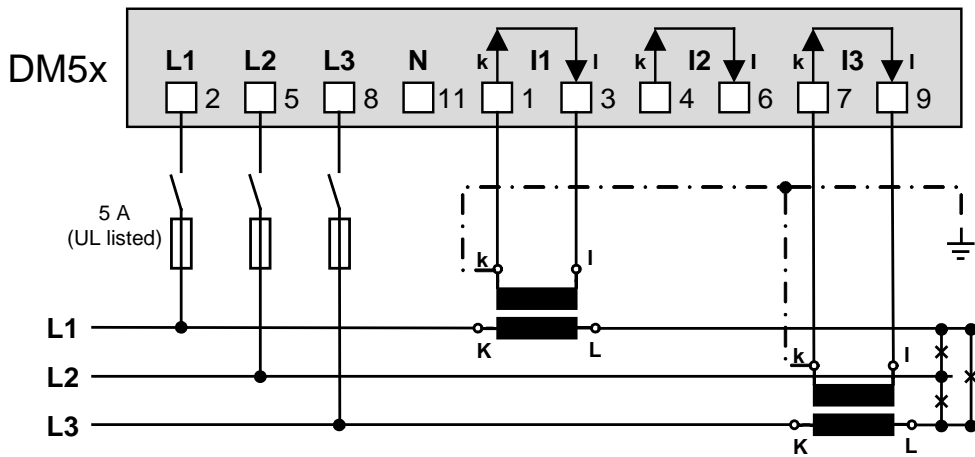

- With current and 3 single-pole isolated voltage transformers

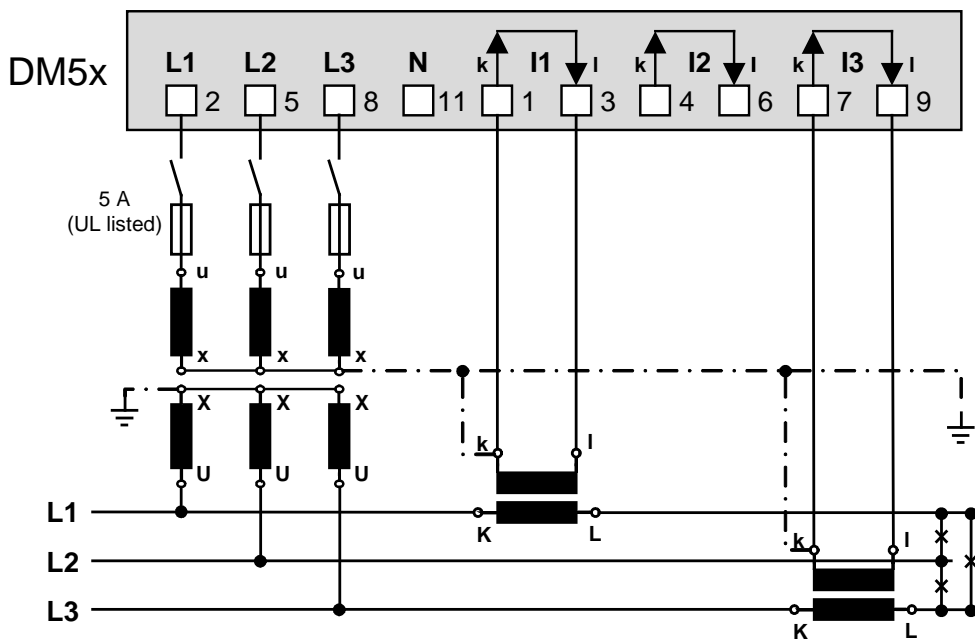

Four wire system, unbalanced load

- Direct connection

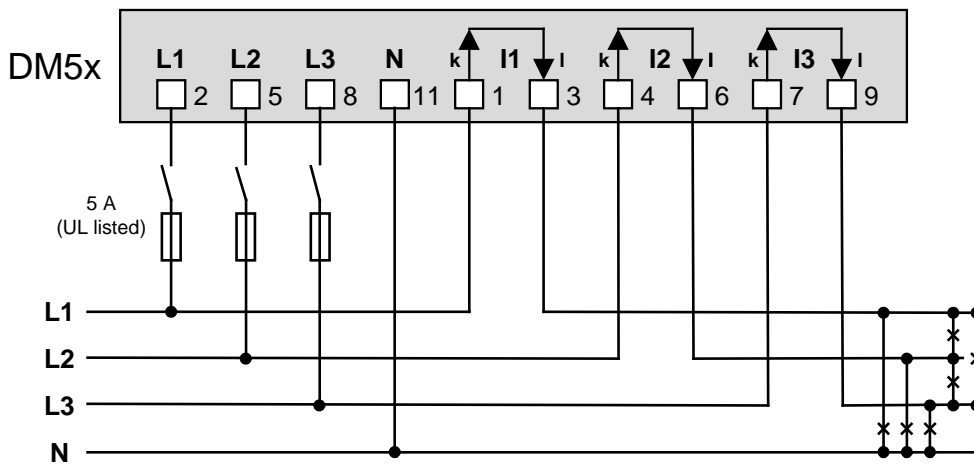

- With current transformer

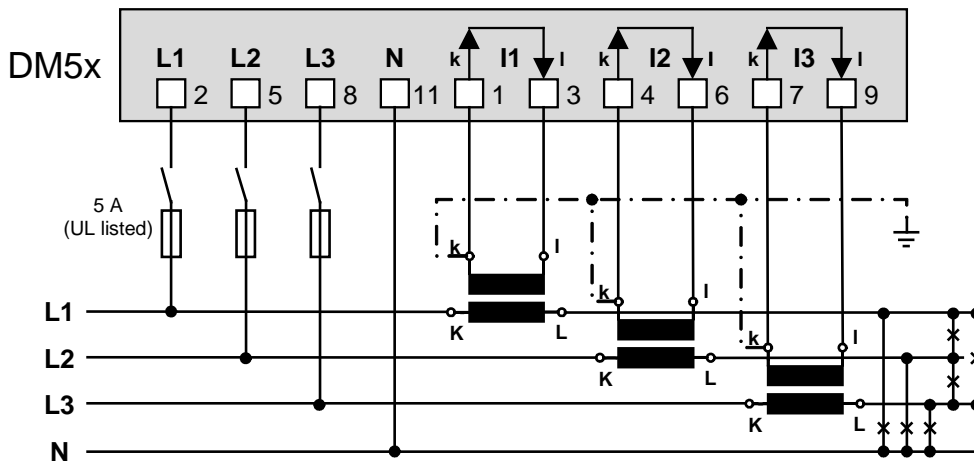

- With current and 3 single-pole isolated voltage transformers

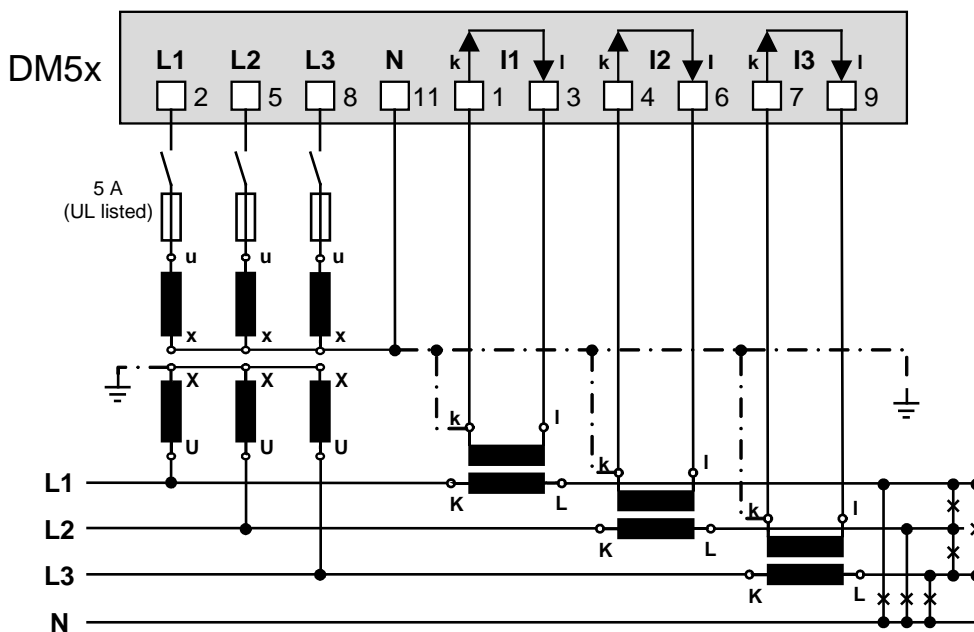

Four wire system, unbalanced load, Open-Y connection

- Direct connection

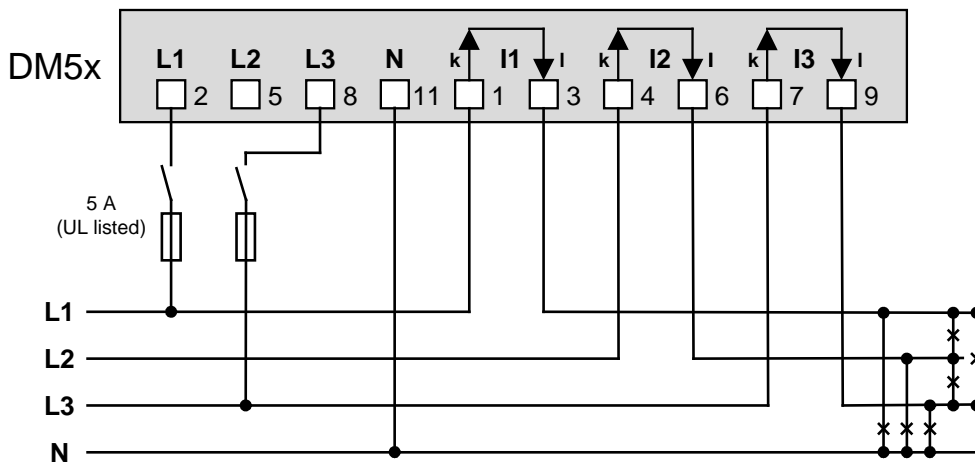

- With current transformer

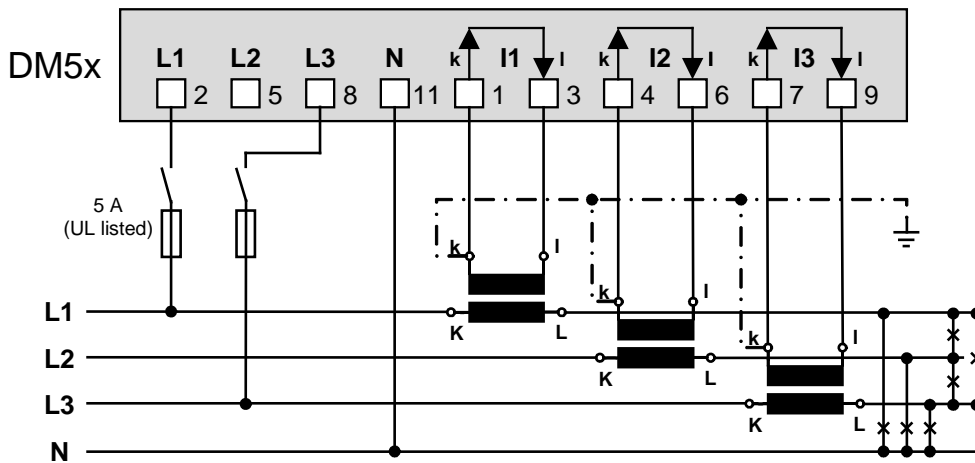

- With current and 2 single-pole isolated voltage transformers

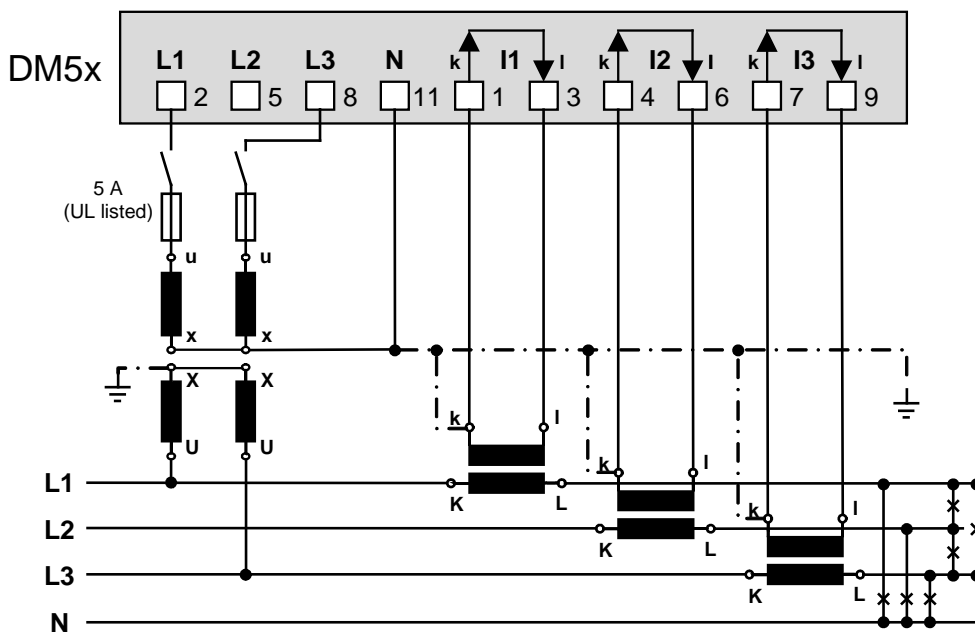

5.5 Power supply



A marked and easily accessible current limiting switch has to be arranged in the vicinity of the device for turning off the power supply. Fusing should be 10 Amps or less and must be rated for the available voltage and fault current.

5.6 Analog outputs

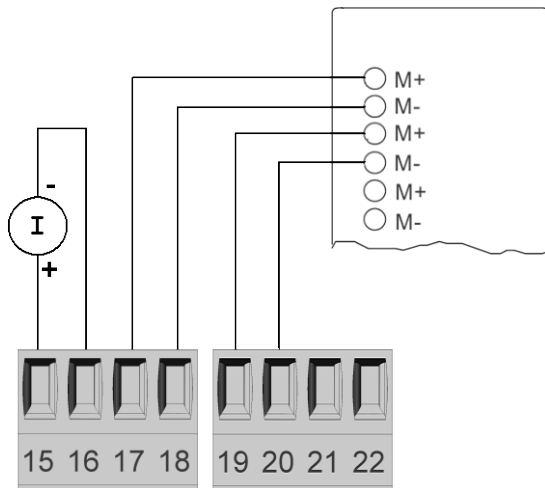

Connection to an analog input card of a PLC or a control system

The DM5 is an isolated measurement device. In addition the particular outputs are galvanically isolated. To reduce the influence of disturbances shielded a twisted-pair cables should be used. The shield should be connected to earth on both opposite ends. If there a potential differences between the ends of the cable the shield should be earthed on one side only to prevent from equalizing currents.

Under all circumstances consider as well appropriate remarks in the instruction manual of the system to connect.

5.7 Modbus interface RS485

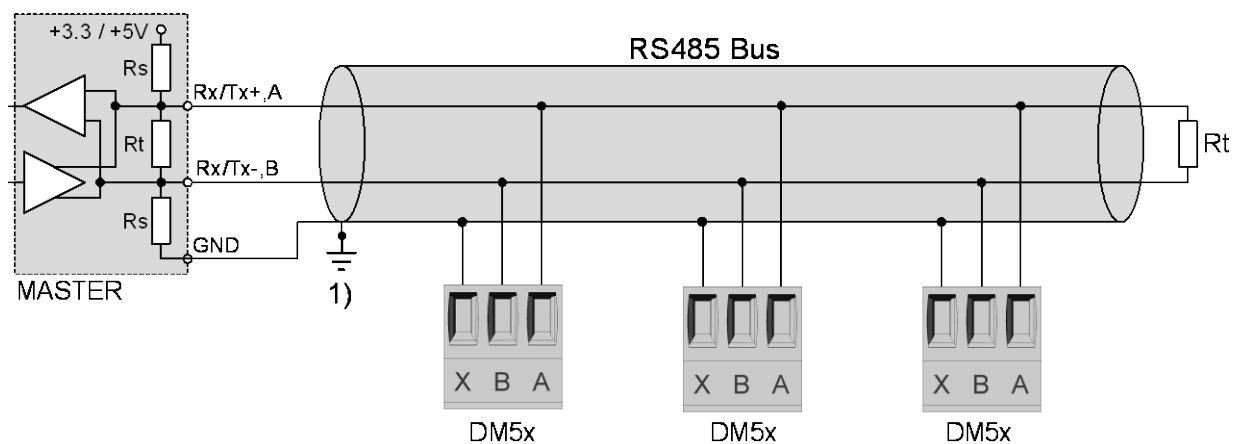

1) One ground connection only. This is possibly made within the master (PC).

Rt: Termination resistors: 120 Ω each for long cables (> approx. 10 m)

Rs: Bus supply resistors, 390 Ω each

The signal wires (A, B) have to be twisted. GND (X) can be connected with a wire or with the cable screen. In disturbed environments shielded cables must be used. Supply resistors (Rs) have to be present in the bus master (PC, PLC, control system) interface. Stubs should be avoided when connecting the devices. A pure daisy chain network is ideal.

You may connect up to 32 Modbus devices. To assure operation all of the devices must have equal communication settings (baud rate, transmission format) and unique Modbus addresses.

The bus system is operated half duplex and may be extended to a maximum length of 1200 m without repeater.

5.8 USB configuration interface

The USB interface serves for configuration and commissioning of the DM5. It is not intended for measurement processing during normal operation !



If the USB interface is connected during normal operation measurements may be slightly distorted ! This can be prevented by using a USB cable with galvanical isolation !



The device can be configured via USB interface even if there is no power supply connected.

6. Commissioning



Before commissioning you have to check if the connection data of the transducer match the data of the plant (see nameplate).

If so, you can start to put the device into operation by switching on the power supply and the measurement inputs.

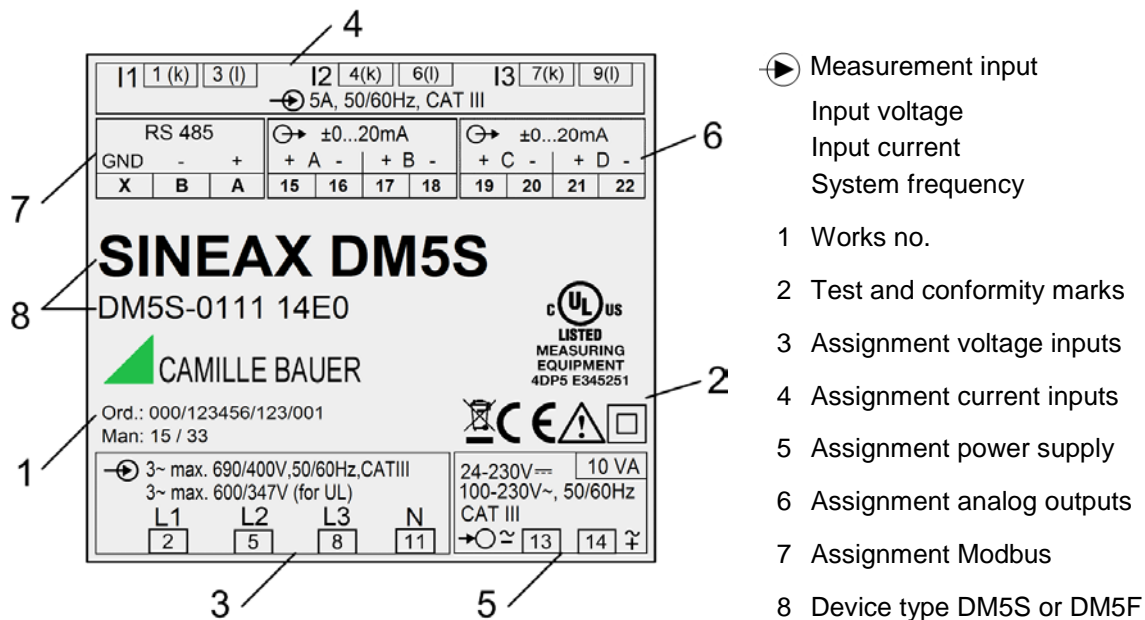

- ▶ Measurement input
- Input voltage
- Input current
- System frequency
- 1 Works no.
- 2 Test and conformity marks
- 3 Assignment voltage inputs
- 4 Assignment current inputs
- 5 Assignment power supply
- 6 Assignment analog outputs
- 7 Assignment Modbus
- 8 Device type DM5S or DM5F

6.1 Software installation CB-Manager

A complete parametrization of the device is possible via configuration interface only, using the PC software CB-Manager. The software may be downloaded free of charge from our homepage <http://www.camillebauer.com>.



The file "Read-me-first" on the Doku-CD provides all necessary information for the installation of the CB-Manager software and assistance for possible problems.

Functionality of the CB-Manager software

The software is primary a tool for the configuration of different devices (DM5x, APLUS, CAM, VR660, A200R, Vx604s) and supports the user during commissioning and service. It allows as well the reading and visualization of measured data.

- ▶ Reading and changing of all device features
- ▶ Archiving of configuration and measurement files
- ▶ Visualization of present measurements
- ▶ Reading, setting and resetting of meters
- ▶ Reading and resetting of maximum values
- ▶ Recording of measurement progressions during commissioning
- ▶ Check for correct device connection
- ▶ Simulation of outputs to test subsequent circuits
- ▶ Adjust the security system as protection against unauthorized access or manipulations

The CB-Manager software provides a comprehensive help facility, which describes in detail the operation of the software as well as all possible parameter settings.

6.2 Parametrization of the device functionality

Operating the software

The device configuration is divided into registers, which contain thematically the different function blocks of the device, e.g. "input", "I/O", "Meters". Thereby of course there are interdependencies, which have to be considered. Therefore a meaningful sequence must be kept during setting the parameters. The easiest way is to handle register by register and line by line:

- ▶ **Device** (set the device version, if not read directly from the device). Using the device version SINEAX DM5F the behavior of a SINEAX DM5S can be emulated by selecting the field „(DM5S)“ next to it.
- ▶ **Input**, especially system and transformer ratios
- ▶ **Meters**: Selection of meters and assigned tariffs (DM5S only)
- ▶ if present: **I/O 1,2 >> I/O 3,4**
- ▶ **Modbus-Image** (if you want to use your own Modbus image)
- ▶ **LEDs**: Definition of the LED functionality

The screenshot shows the configuration software interface for a SINEAX DM5 device. The interface is divided into several sections:

- Device**: A dropdown menu is set to "DM5F". There is a checkbox for "(DM5S)" which is currently unchecked. An "ID" field contains the value "0".
- description**: A text field containing "DM5F".
- TAG**: A text field containing a hyphen "-".
- firmware version**: A table with two rows: "input" with value "1.00.0000" and "display" with value "1.00.0000".
- device type**: Contains checkboxes for "display" (unchecked) and "RS485 (MODBUS)" (checked). Other fields include "FRAM" (16 kBit) and "NLB" (0). A dropdown menu shows "3 Voltages, 3 Currents".
- MODBUS**: Fields for "device address" (1), "baudrate" (19200), "parity" (none), "data bits" (8), "stopbits" (1), and "Response Delay" (100ms).
- I/O's**: A dropdown menu shows "4 x Anout". Below it are two columns of fields: the first column has fields 1, 2, 3, and 4, all labeled "Analog output"; the second column has fields 5 and 6, both with "--" in them.
- Security system**: A checkbox which is currently unchecked.

ONLINE / OFFLINE

The parametrization may be performed ONLINE (with existing connection to the device) or OFFLINE (without connection to the device). To perform an ONLINE configuration first the configuration of the connected device, and therewith its hardware version, is read. A modified configuration can then be downloaded to the device and stored on the hard disk of the computer for archiving.

An OFFLINE parametrization can be used to prepare device configurations, to store them on disk and to download it to the devices, once you are in the field where the devices are installed. To make this work, the device versions selected during parametrization must agree with the versions on site.

6.3 Installation check

Check if inputs are connected correctly

► Voltage (at least 20% U_{rated}) and current (at least 2% I_{rated}) must be present

Using the connection check, which is integrated in the visualization of the instantaneous values, the correct connection of the current and voltage inputs may be checked. The phase sequence will be checked, as well as if there are open connections or reversed current connections (which change the direction of the current).

The image below shows open current connections (red highlighted I1, I2, I3). This arises because the individual currents are below 2% of the rated value.

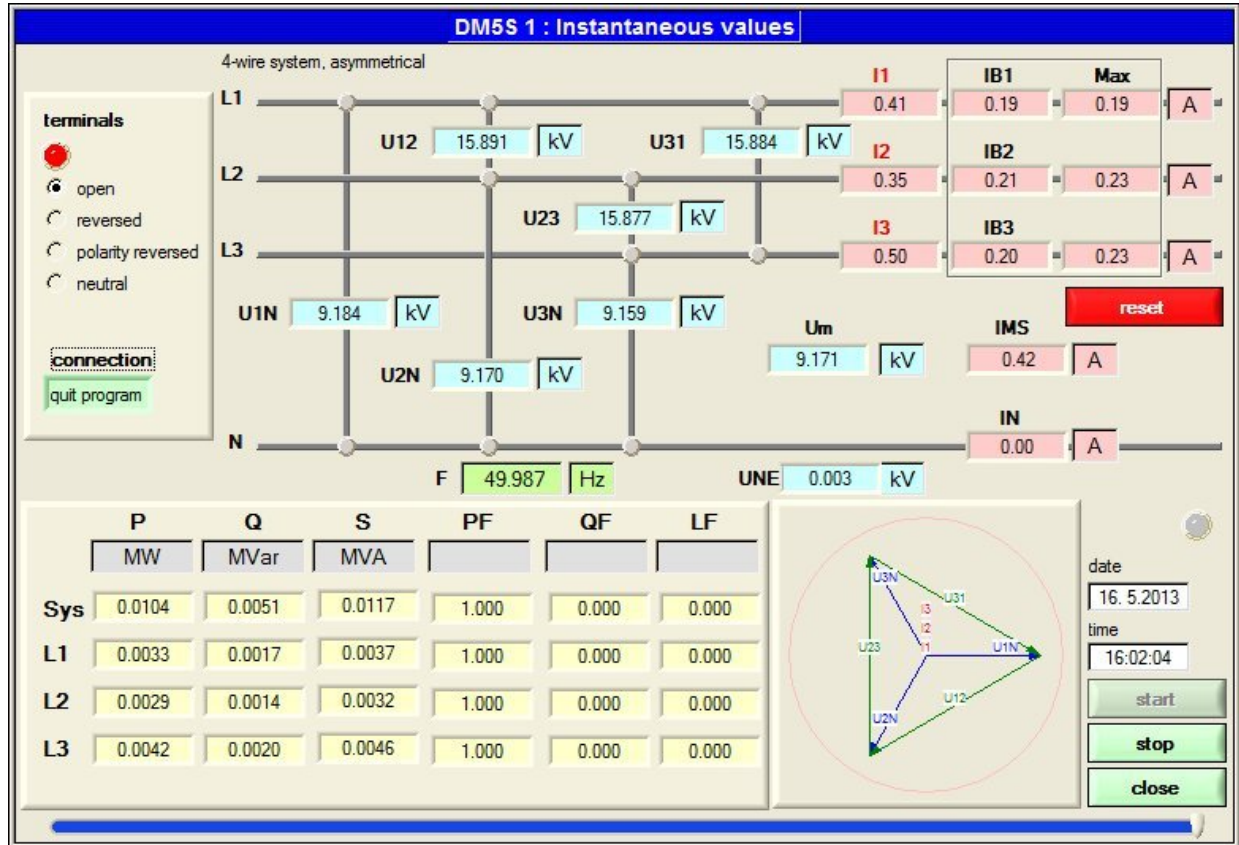

Simulation of I/O's

To check if subsequent circuits will work properly with the measurement data provided by the DM5 all analog outputs may be simulated, by predefining any output value by means of the CB-Manager software.

6.4 Protection against device data changing

Data stored in the device may be modified or reset via communication interface. To restrict these possibilities on-site, via CB-Manager the security system in the device can be activated (factory default: not activated). For the definition of these user rights in the software the input of an administrator login is required. The factory default is:

user: admin
password: admin

 The administrator password may be modified, but a reset can be performed in our factory only !

For a specific user the access to selectable functions can individually be granted.

6.5 LED functionality

The DM5x provides three LEDs for on-site display. The following default functionality is assigned to the LEDs at the factory (from top to bottom):

- LED A (yellow): Modbus activity
- LED B (yellow): USB activity
- LED C (green): Power supply present and / or USB interface connected ¹⁾

Function and description of LED A and LED B are user programmable. For device identification the description of LED C (POWER) can be overwritten with the device description. The associated label can then be printed by means of the CB-Manager software.

- ¹⁾ **Hint:** For the parameterization of the DM5x the device can be powered via USB interface, no power supply need to be connected. Also in this case LED C lights. However, for Modbus communication, the measurement of the input signals and for driving analog outputs power via the power supply terminals is required.



7. Service, maintenance and disposal

7.1 Protection of data integrity

The DM5 supports security mechanism, which serve to prevent manipulation or undesired modifications of device data.

► [Protection against device data modifications](#)

7.2 Calibration and new adjustment

Each device is adjusted and checked before delivery. The condition as supplied to the customer is measured and stored in electronic form.

The uncertainty of measurement devices may be altered during normal operation if, for example, the specified ambient conditions are not met. If desired, in our factory a calibration can be performed, including a new adjustment if necessary, to assure the accuracy of the device.

7.3 Cleaning

If necessary wipe the device using a clean, dry and soft cloth.



Damage due to detergents

Detergents can damage the device. Therefore, do not use detergents.

7.4 Disposal

The product must be disposed in compliance with local regulations.

8. Technical data

Inputs	via screw terminals 6mm ²
Nominal current:	adjustable 1...5 A
Maximum:	7.5 A (sinusoidal)
Consumption:	$\leq I^2 \times 0.01 \Omega$ per phase
Overload capacity:	10 A continuous 100 A, 10 x 1 s, interval 100 s
Nominal voltage:	IEC: 57.7...400 V _{LN} , 100...693 V _{LL} UL: 57.7...347 V _{LN} , 100...600 V _{LL}
Maximum:	480 V _{LN} , 832 V _{LL} (sinusoidal)
Consumption:	$\leq U^2 / 1.54 \text{ M}\Omega$ per phase
Impedance:	1.54 M Ω per phase
Overload capacity:	480 V _{LN} , 832 V _{LL} continuous 600 V _{LN} , 1040 V _{LL} , 10 x 10 s, interval 10s 800 V _{LN} , 1386 V _{LL} , 10 x 1 s, interval 10s
Systems:	Single phase Split phase (2-phase system) 3-wire, balanced load 3-wire, balanced load, phase-shift (DM5S only) 3-wire, unbalanced load 3-wire, unbalanced load, Aron connection 4-wire, balanced load 4-wire, unbalanced load 4-wire, unbalanced load, Open-Y
Nominal frequency:	45... <u>50 / 60</u> ...65Hz
Measurement TRMS:	Up to the 31st harmonic
Power supply	via screw terminals 6mm ²
Nominal voltage:	100...230V AC $\pm 15\%$, 50 / 60Hz 24...230V DC $\pm 15\%$
Consumption:	$\leq 10 \text{ VA}$, depending on the device hardware used

Measurement uncertainty

Reference conditions: Ambient 23°C ±1K, sinusoidal input signals (form factor 1.1107),
(acc. IEC/EN 60688) no fixed frequency for sampling, PF=1, frequency 50...60Hz, burden 250 Ω

SINEAX DM5S

Measurement time	8 cycles
Voltage, current ^{1) 2)}	± 0,15% FSU, FSI
U _{NE} , I _N ^{1) 2)}	± 0,5% FSU, FSI
Power ²⁾	± 0,20% (FSU * FSI)
Power factor ²⁾	± 0,1°
Frequency	± 0,01 Hz
Active energy	Class 0.5S, EN 62053-22
Reactive energy	Class 2, EN 62053-23

SINEAX DM5F

Measurement time	1 cycle	1/2,1 cycle ³⁾	1/2 cycle ⁴⁾
Voltage, current ^{1) 2)}	± 0,15% FSU, FSI	± 0,25% FSU, FSI	± 0,35% FSU, FSI
U _{NE} , I _N ^{1) 2)}	± 0,5% FSU, FSI	± 0,5% FSU, FSI	± 0,8% FSU, FSI
Power ²⁾	± 0,2% (FSU * FSI)	± 0,3% (FSU * FSI)	± 0,5% (FSU * FSI)
Power factor ²⁾	± 0,1°	± 0,2°	± 0,4°
Frequency	± 0,01 Hz	± 0,01 Hz	± 0,01 Hz

Measurement with fixed system frequency:

General	± Basic uncertainty x (F _{konfig} - F _{ist}) [Hz] x 10
U _{NE} , I _N	± 3 x Basic uncertainty U _{NE} , I _N (up to ± 0.5 Hz)

Zero suppression, range limitations

Specific measurements can be determined and given to the analog outputs or the bus interface only if certain pre-conditions are fulfilled. If these conditions are not fulfilled, a default value is used for these measurements.

Quantity	Condition	Default
Voltage	$U_x < 1\% U_{x_{max}}$	0.00
Current	$I_x < 0,1\% I_{x_{rated}}$	0.00
PF	$S_x < 1\% S_{x_{max}}$	1.00
QF, LF	$S_x < 1\% S_{x_{max}}$	0.00
Frequency	voltage and/or current input too low ¹⁾	44.90

¹⁾ FSU, FSI – Configured maximum value of voltage / current inputs

²⁾ Additional uncertainty if neutral wire not connected (3-wire connection)

- Voltage, power: 0.1% of measured value; load factor: 0.1°
- Energy: Voltage influence x 2, Angle influence x 2

³⁾ 1/2, 1: Each half cycle new values will be calculated. For determining the RMS values a sliding one-cycle window is applied, which is built from the last two half cycles measured.

⁴⁾ 1/2: Each half cycle new values will be calculated. For determining the RMS values the last measured half cycle is extrapolated

⁵⁾ specific level depends on the device configuration

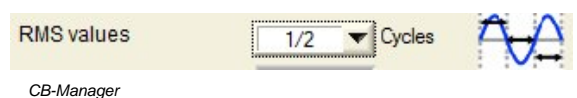
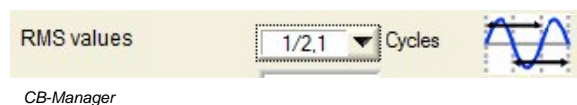

Analog outputs via plug-in terminals 2.5mm², galvanically isolated

Linearization: Linear, kinked
Range: ± 20 mA (24 mA max.), bipolar
Uncertainty: ± 0.1% of 20 mA (included in basic uncertainty)
Burden: ≤ 500 Ω (max. 10 V / 20 mA)
Burden influence: ≤ 0.1%
Residual ripple: ≤ 0.2%
Response time (at 50Hz): DM5S: 85...165 ms (for 4 cycles averaging time of RMS values)
DM5F: 15...25 ms (for ½ cycle measurement time)

Interface

Modbus/RTU via plug-in terminals
Protocol: Modbus RTU
Physics: RS-485, max. 1200m (4000 ft)
Baud rate: 2'400, 4'800, 9'600, 19'200, 38'400, 57'600, 115'200 Baud
Number of participants: ≤ 32

Ambient conditions, general information

Operating temperature: -20 up to 22 up to 24 up to + 55°C
Storage temperature: -25 up to + 70°C
Temperature influence: 0.5 x measurement uncertainty per 10 K
Long term drift: 0.5 x measurement uncertainty per year
Others: Usage group II (EN 60 688)
Relative humidity: < 95% no condensation
Altitude: ≤ 2000 m max.
Device to be used indoor only !

Mechanical attributes

Housing material: Polycarbonat
Flammability class: V-0 acc. UL94, non-dripping,
free of halogen
Weight: 250 g

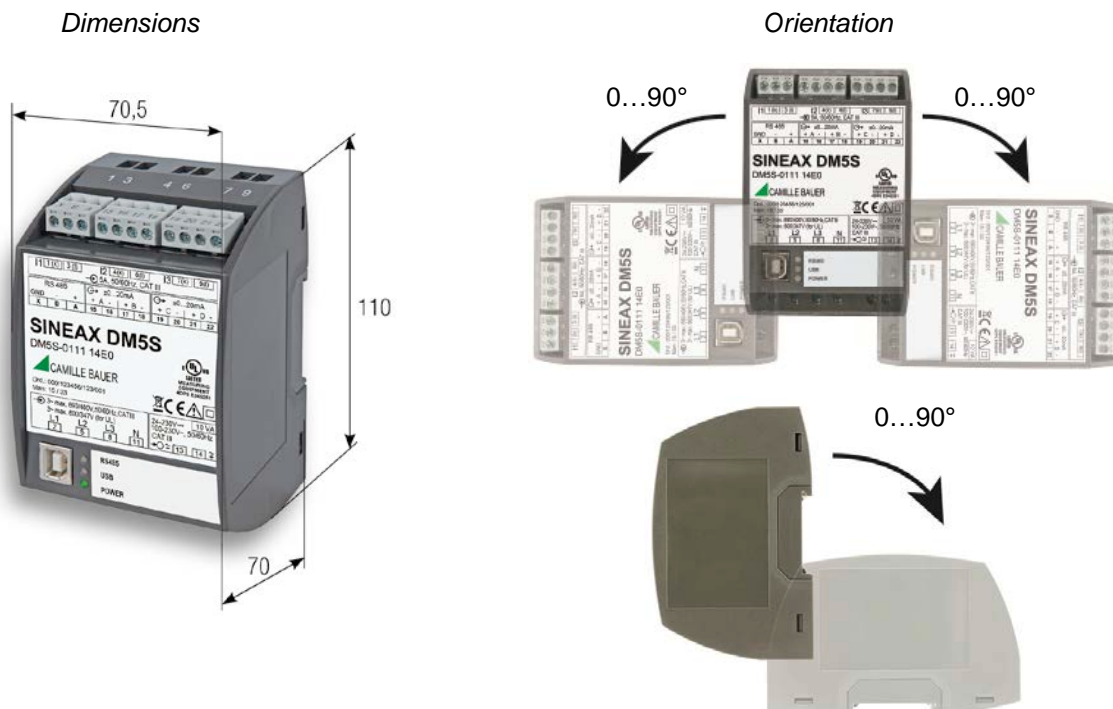

Vibration withstand (test according to DIN EN 60 068-2-6)

Acceleration:	± 2 g
Frequency range:	10 ... 150 ... 10 Hz, rate of frequency sweep: 1 octave/minute
Number of cycles:	10 in each of the 3 axes

Security

The current inputs are galvanically isolated from each other

Protection class: II (protective insulation, voltage inputs via protective impedance)

Pollution degree: 2

Protection: IP30 (housing), IP20 (terminals)

Measurement category: CAT III up to 600V

Rated voltage power supply: 265 V AC

(versus earth): I/O's: 30 V DC

Test voltages: AC, 60s, acc. IEC/EN 61010-1 (2010)

- power supply versus inputs U, I: 3600V AC
- power supply versus Modbus, analog outputs: 3000V AC
- inputs U versus inputs I: 3600V AC
- inputs U versus Modbus, analog outputs: Current limitation by protective impedance
- inputs I versus Modbus, analog outputs: 3600V AC
- inputs I versus inputs I: 1800V AC

The device uses the principle of protective impedance for the voltage inputs to ensure protection against electric shock. All circuits of the device are tested during final inspection.



Prior to performing high voltage or isolation tests involving the voltage inputs, all output connections of SINEAX DM5S or DM5F, especially analog outputs, Modbus and USB interface, must be removed. A possible high-voltage test between input and output circuits must be limited to 500V DC, otherwise electronic components can be damaged.

Applied regulations, standards and directives

IEC/EN 61 010-1	Safety regulations for electrical measuring, control and laboratory equipment
IEC/EN 60 688	Electrical measuring transducers for converting AC electrical variables into analog or digital signals
DIN 40 110	AC quantities
IEC/EN 60 068-2-1/ -2/-3/-6/-27:	Ambient tests -1 Cold, -2 Dry heat, -3 Damp heat, -6 Vibration, -27 Shock
IEC/EN 60 529	Protection type by case
IEC/EN 61 000-6-2/ 61 000-6-4:	Electromagnetic compatibility (EMC) Generic standard for industrial environment
IEC/EN 61 326	Electrical equipment for measurement, control and laboratory use - EMC requirements
UL94	Tests for flammability of plastic materials for parts in devices and appliances
2002/95/EG (RoHS)	EC directive on the restriction of the use of certain hazardous substances

Warning

This is a class A product. In a domestic environment this product may cause radio interference in which case the user may be required to take adequate measures.

This device complies with part 15 of the FCC:

Operation is subject to the following two conditions: (1) This device may not cause harmful interference, and (2) this device must accept any interference received, including interference that may cause undesired operation.

This Class A digital apparatus complies with Canadian ICES-0003.

Annex

A Description of measured quantities

Used abbreviations

- 14 Single phase system or
4-wire system with balanced load or
3-wire system with balanced load, phase shift (DM5S only)
- 2L Split phase; system with 2 phases and centre tap
- 3G 3-wire system with balanced load
- 3U 3-wire system with unbalanced load
- 3A 3-wire system with unbalanced load, Aron connection (only 2 currents connected)
- 4U 4-wire system with unbalanced load
- 4O 4-wire system with unbalanced load, Open-Y (reduced voltage connection)

A1 Basic measurements

These measured quantities are determined using the configured measurement time. If a measurement is available depends on the selected system.

Measurement	14	2L	3G	3U	3A	4U	4O
System voltage	•	•	-	-	-	-	-
Voltage L1-N	-	•	-	-	-	•	•
Voltage L2-N	-	•	-	-	-	•	•
Voltage L3-N	-	-	-	-	-	•	•
Voltage L1-L2	-	-	•	•	•	•	•
Voltage L2-L3	-	-	•	•	•	•	•
Voltage L3-L1	-	-	•	•	•	•	•
Zero displacement voltage	-	-	-	-	-	•	•
System current	•	-	•	-	-	-	-
Current in phase L1	-	•	-	•	•	•	•
Current in phase L2	-	•	-	•	•	•	•
Current in phase L3	-	-	-	•	•	•	•
Neutral current (calculated)	-	•	-	-	-	•	•
Active power of the system	•	•	•	•	•	•	•
Active power in phase L1	-	•	-	-	-	•	•
Active power in phase L2	-	•	-	-	-	•	•
Active power in phase L3	-	-	-	-	-	•	•
Active power of the system	•	•	•	•	•	•	•
Reactive power in phase L1	-	•	-	-	-	•	•
Reactive power in phase L2	-	•	-	-	-	•	•
Reactive power in phase L3	-	-	-	-	-	•	•
Apparent power of the system	•	•	•	•	•	•	•
Apparent power in phase L1	-	•	-	-	-	•	•
Apparent power in phase L2	-	•	-	-	-	•	•
Apparent power in phase L3	-	-	-	-	-	•	•

Measurement	14	2L	3G	3U	3A	4U	4O
System frequency	•	•	•	•	•	•	•
Active power factor of the system, PF=P / S	•	•	•	•	•	•	•
Active power factor in phase L1	-	•	-	-	-	•	•
Active power factor in phase L2	-	•	-	-	-	•	•
Active power factor in phase L3	-	-	-	-	-	•	•
Reactive power factor of the system, QF=Q / S	•	•	•	•	•	•	•
Reactive power factor in phase L1	-	•	-	-	-	•	•
Reactive power factor in phase L2	-	•	-	-	-	•	•
Reactive power factor in phase L3	-	-	-	-	-	•	•
LF factor of the system, sign(Q)·(1- abs(PF))	•	•	•	•	•	•	•
LF factor in phase L1	-	•	-	-	-	•	•
LF factor in phase L2	-	•	-	-	-	•	•
LF factor in phase L3	-	-	-	-	-	•	•
Average voltage	•	•	•	•	•	•	•
Average current	•	•	•	•	•	•	•
Average current with sign of P	•	•	•	•	•	•	•
Bimetal current of the system	•	-	•	-	-	-	-
Bimetal current in phase L1	-	•	-	•	•	•	•
Bimetal current in phase L2	-	•	-	•	•	•	•
Bimetal current in phase L3	-	-	-	•	•	•	•
Slave pointer of bimetal current of the system	•	-	•	-	-	-	-
Slave pointer of bimetal current in phase L1	-	•	-	•	•	•	•
Slave pointer of bimetal current in phase L2	-	•	-	•	•	•	•
Slave pointer of bimetal current in phase L3	-	-	-	•	•	•	•

Power factors

The **power factor PF** gives the relation between active and apparent power. If there are no harmonics present in the system, it corresponds to the $\cos\varphi$. PF has a range of $-1 \dots 0 \dots +1$, where the sign gives the direction of energy flow.

The **load factor LF** is a quantity derived from the PF, which allows making a statement about the load type. Only this way it's possible to measure a range like 0.5 capacitive ... 1 ... 0.5 inductive in a non-ambiguous way.

The **reactive power factor QF** gives the relation between reactive and apparent power.

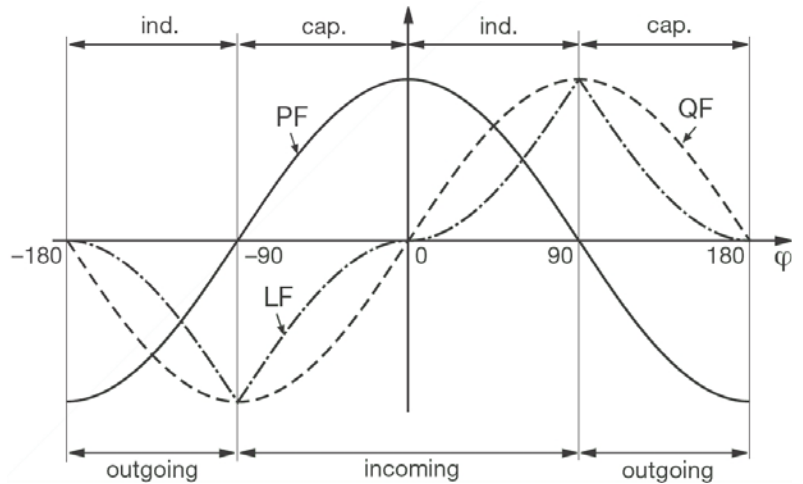

Zero displacement voltage U_{NE}

Starting from the generating system with star point E (which is normally earthed), the star point (N) on load side is shifted in case of unbalanced load. The zero displacement voltage between E and N may be determined by a vectorial addition of the voltage vectors of the three phases:

$$\underline{U}_{NE} = -(\underline{U}_{1N} + \underline{U}_{2N} + \underline{U}_{3N}) / 3$$

A displacement voltage may also occur due to harmonics of order 3, 9, 15, 21 etc., because the dedicated currents add in the neutral wire.

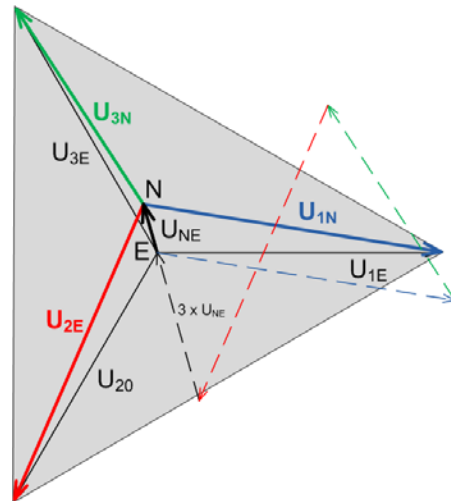

A2 Meters (DM5S only)

The DM5S supports up to 32 energy meters. To each of these meters a base measurement quantity and a tariff can be assigned. The present tariff is set via Modbus.

For application with short measurement times, e.g. energy consumption for a single working day or production lot, the resolution can be adapted.

Thanks to uninterrupted measurement and automatically range detection a high accuracy is achieved.

B Declaration of conformity

B1 CE conformity



**EG - KONFORMITÄTSERKLÄRUNG
EC DECLARATION OF CONFORMITY**



Dokument-Nr./ Document.No.: DM5_CE-konf.docx
 Hersteller/ Manufacturer: **Camille Bauer Metrawatt AG**
 Switzerland
 Anschrift / Address: **Aargauerstrasse 7**
 CH-5610 Wohlen
 Produktbezeichnung/
 Product name: **Multi-Messumformer mit Analogausgängen und Modbus-Schnittstelle**
 Multifunctional transducer with analog outputs and Modbus interface
 Typ / Type: **SINEAX DM5S / SINEAX DM5F**

Das bezeichnete Produkt stimmt mit den Vorschriften folgender Europäischer Richtlinien überein, nachgewiesen durch die Einhaltung folgender Normen:
 The above mentioned product has been manufactured according to the regulations of the following European directives proven through compliance with the following standards:

Richtlinie / Directive	2004/108/EG(CE) Elektromagnetische Verträglichkeit - EMV-Richtlinie Electromagnetic compatibility - EMC directive	
Norm / Standard	EN 61000-6-2: 2005 Fachgrundnormen - Störfestigkeit für Industriebereiche Generic standards - Immunity for industrial environments	
	EN 61000-6-4: 2007 Fachgrundnormen - Störaussendung für Industriebereiche Generic standards - Emission standard for industrial environments	
Prüfungen / Tests	IEC 61000-4-2 IEC 61000-4-3 IEC 61000-4-4 IEC 61000-4-5 IEC 61000-4-6 IEC 61000-4-8 IEC 61000-4-11	EN 55011

Richtlinie / Directive	2006/95/EG(CE) Elektrische Betriebsmittel zur Verwendung innerhalb bestimmter Spannungsgrenzen – Niederspannungsrichtlinie – CE-Kennzeichnung : 95 Electrical equipment for use within certain voltage limits – Low Voltage Directive – Attachment of CE marking : 95	
Norm / Standard	EN 61010-1: 2010 Sicherheitsbestimmungen für elektrische Mess-, Steuer-, Regel- und Laborgeräte – Teil 1: Allgemeine Anforderungen Safety requirements for electrical equipment for measurement, control and laboratory use – Part 1: General requirements EN 61010-2-30: 2010 Besondere Bestimmungen für Prüf- und Messstromkreise Particular requirements for testing and measuring circuits	

Ort, Datum / Place, date: Wohlen, 03. Dezember 2014
 Unterschrift / signature:

M. Ulrich
 Leiter Technik / Head of engineering

J. Brem
 Qualitätsmanager / Quality manager

B2 FCC statement

The following statement applies to the products covered in this manual, unless otherwise specified herein. The statement for other products will appear in the accompanying documentation.

NOTE: This equipment has been tested and found to comply with the limits for a Class A digital device, pursuant to Part 15 of the FCC Rules and meets all requirements of the Canadian Interference-Causing Equipment Standard ICES-003 for digital apparatus. These limits are designed to provide reasonable protection against harmful interference in a residential installation. This equipment generates, uses, and can radiate radio frequency energy and, if not installed and used in accordance with the instructions, may cause harmful interference to radio communications. However, there is no guarantee that interference will not occur in a particular installation. If this equipment does cause harmful interference to radio or television reception, which can be determined by turning the equipment off and on, the user is encouraged to try to correct the interference by one or more of the following measures:

- Reorient or relocate the receiving antenna.
- Increase the separation between the equipment and receiver.
- Connect the equipment into an outlet on a circuit different from that to which the receiver is connected.
- Consult the dealer or an experienced radio/T.V. technician for help.

Camille Bauer AG is not responsible for any radio television interference caused by unauthorized modifications of this equipment or the substitution or attachment of connecting cables and equipment other than those specified by Camille Bauer AG. The correction of interference caused by such unauthorized modification, substitution or attachment will be the responsibility of the user.

INDEX

A		L	
Auto-scaling	6	LED	28
C		M	
Commissioning	25	Measured quantities	34
D		Basic measurements	34
Declaration of conformity	37	meters	36
Device overview	5	power factors	36
E		zero displacement voltage	36
Electrical connections		Measurement	
analog outputs	23	continuous	6
cross sections	10	Mechanical mounting	8
Four-wire balanced load	18	Metering	6
Four-wire Open-Y	22	Modbus image	7
Four-wire unbalanced	21	Modes of operation	6
Modbus interface	23	N	
power supply	23	Nameplate	25
Single-phase AC mains	12	S	
Split-phase	13	Scope of supply	4
Three-wire Aron	20	Security notes	5
Three-wire balanced load	17	Service and maintenance	29
Three-wire phase-shift	14	Software	
Three-wire unbalanced load	19	CB-Manager	25
USB configuration interface	24	online / offline	26
F		operating	26
FCC statement	38	security system	27
I		Simulation of I/O's	27
Installation check	27	T	
L		Technical data	30
C		Z	
D		Zero suppression	31